

M12 male 0° / M12 female 0° B-cod. shielded

PUR 1x2xAWG22 shielded vt UL/CSA+drag ch. 5m

PROFIBUS

Male straight – female straight

M12, 4-pole – M12, 2-pole

B-coded

shielded

Plastic housings with good resistance against chemicals and oils.

The resistance to aggressive media should be individually tested for your application. Further details on request.

Further cable lengths on request.

[Link to Product](#)

Illustration

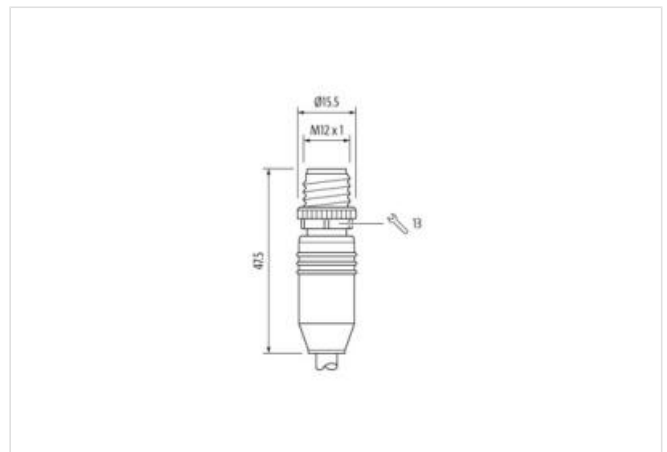



Product may differ from Image



Cable length 5 m

Side 1

Tightening torque	0,6 Nm
Mounting method	inserted, screwed
Family construction form	M12
Thread	M12 x 1
Coding	B
Material	PUR
Width across flats	SW13

Side 2

Tightening torque	0,6 Nm
Mounting method	inserted, screwed
Family construction form	M12
Thread	M12 x 1
Coding	B
Material	PUR

Commercial data

ECLASS-6.0	27061801
ECLASS-6.1	27060307
ECLASS-7.0	27060307
ECLASS-8.0	27060307
ECLASS-9.0	27060307
ECLASS-10.1	27060307
ECLASS-11.1	27060307
ECLASS-12.0	27060307
ETIM-5.0	EC001855
customs tariff number	85444290
GTIN	4048879629836
Packaging unit	1

Electrical data | Supply

Operating voltage AC max.	60 V
Operating voltage DC max.	60 V

Operating voltage AC (UL-listed)	30 V
Operating voltage DC (UL-listed)	30 V
Current operating per contact max.	4 A

Device protection | Electrical

Degree of protection (EN IEC 60529)	IP65, IP67, IP68, IP66K
Additional condition protection degree	inserted, screwed
Pollution Degree	3
Rated surge voltage	1,5 kV
Material group (IEC 60664-1)	I

Mechanical data

Contour for corrugated hose	without
-----------------------------	---------

Mechanical data | Material data

Coating locking	Nickeled
Locking material	Zinc die-casting

Mechanical data | Mounting data

Mounting method	inserted, screwed, Shaking protection
-----------------	---------------------------------------

Environmental characteristics | Climatic

Operating temperature min.	-25 °C
Operating temperature max.	85 °C
Additional condition temperature range	depending on cable quality

Important installation notes

Note on strain relief	Protect the connectors by suitable measures from mechanical loads, e.g. by the usage of cable ties.
Note on bending radius	Attention: Observe the permissible bending radii when laying cables, as the IP protection class can be endangered by excessive bending forces.

Conformity

Product standard	DIN EN 61076-2-101 (M12)
------------------	--------------------------

Installation | Cable

wire arrangement	green, red
Cable identification	786
Jacket Color	violet
Type of Certificate	cURus
Amount stranding	1
Stranding	2 wires with 2 Filler twisted
Banding	Fleece, Foil
Filler	yes
wire arrangement	green, red
Cable weight	81,4 g/m
Material jacket	PUR
Shore hardness jacket	80 Shore A
Freedom from ingredients (jacket)	lead-free, cadmium-free, CFC-free, halogen-free, silicone-free
Outer-diameter (jacket)	8,1 mm
Tolerance outer diameter (sheath)	± 5 %
Material wire insulation	PE
Amount wires	2
Outer diameter insulation	2,8 mm
Outer diameter tolerance core insulation	± 5 %
Shore hardness wire insulation	51 Shore D
Ingredient freeness wire insulation	lead-free, CFC-free
Amount strands (wire)	19
Diameter of single wires	22 AWG
Conductor crosssection (wire)	22 AWG

Material conductor wire	Stranded copper wire, bare
Nominal voltage AC max.	300 V
Current load capacity (standard)	to DIN VDE 0298-4
Current load capacity min. wire	6 A
Characteristic impedance	150 $\Omega \pm 10\%$ @ 1 MHz
Electrical resistance line constant wire	59,4 Ω/km @ 20 °C
AC withstand voltage (wire - wire)	2 kV @ 60 s
Electrical capacity line constant (wire - wire)	30000 pF/km
Power frequency withstand voltage (wire - jacket)	2 kV @ 60 s
AC withstand voltage (wire - shield)	2 kV @ 60 s
Min. operating temperature (static)	-40 °C
Max. operating temperature (fixed)	80 °C
Operating temperature min. (dynamic)	-30 °C
Operating temperature max. (dynamic)	90 °C
Flame resistance	UL 1581 § 1090 IEC 60332-2-2 UL 1581 § 1100 FT2
chemical resistance	Good, application-related testing
Gasoline resistance	Good, application-related testing
Oil resistance	DIN EN 60811-404 Good, application-related testing
Bending radius (fixed)	6 x Outer diameter
Bending radius (dynamic)	12 x Outer diameter
No. of bending cycles (C-track)	3 Mio. @ 25 °C
Traversing distance (C-track)	5 m @ 25 °C
Travel speed (C-track)	3 m/s @ 25 °C