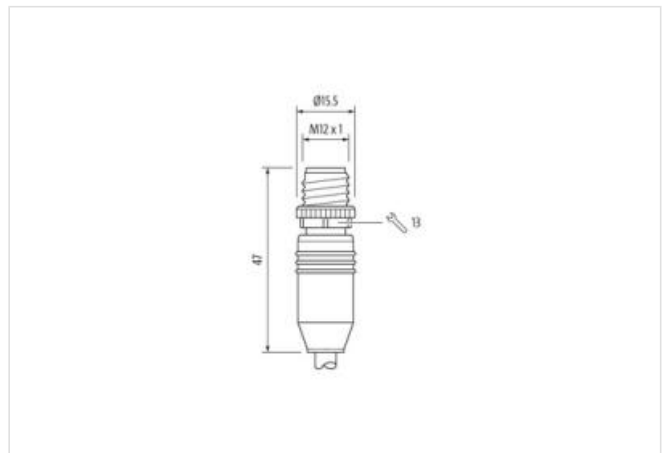
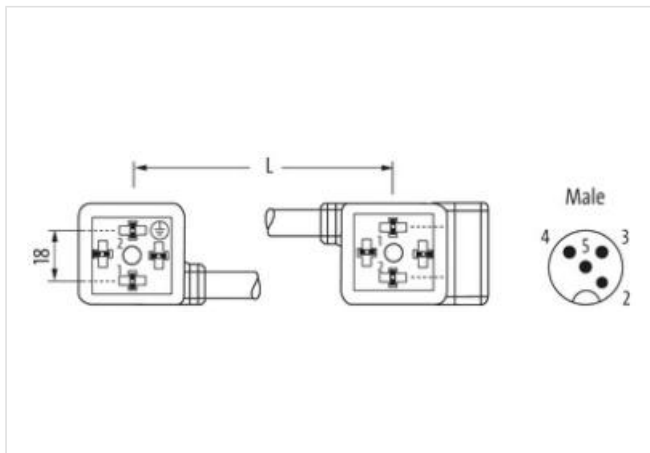
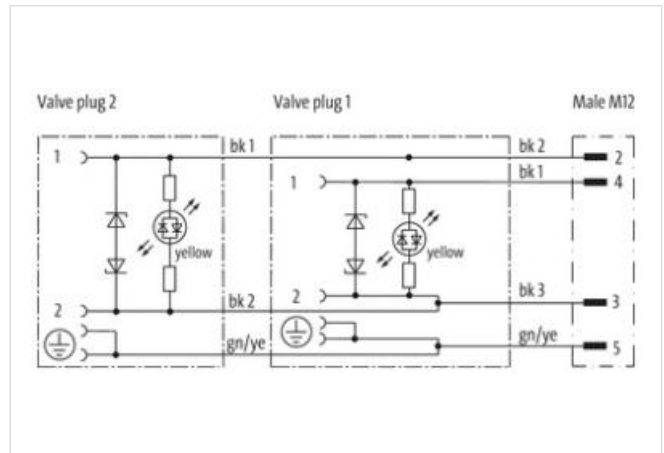
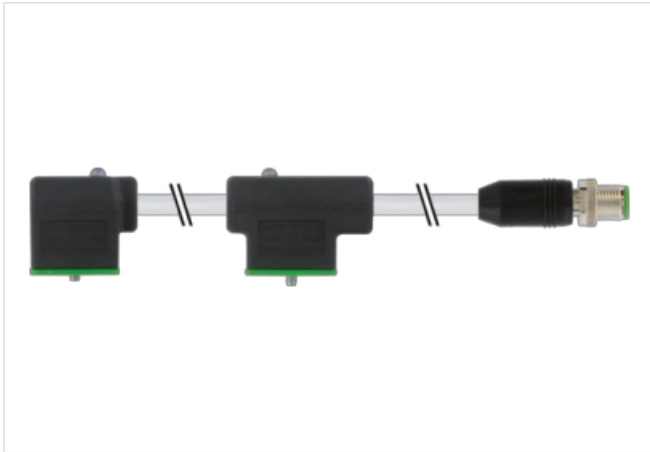

M12 male 0° A-cod. / MSUD double valve A-18mm

PUR 4x0.75 gy UL/CSA 5m

Form A (18 mm) – M12, connector at the rear
 24 V AC $\pm 20\%$ / DC $\pm 25\%$
 LED and suppression
 Connection cable L = 150 mm
 Bridged PE

Plastic housings with good resistance against chemicals and oils.
 The resistance to aggressive media should be individually tested for your application. Further details on request.
 Further cable lengths on request.

[Link to Product](#)**Illustration**



Product may differ from Image



Cable length 5 m

Side 1

Family construction form	MSUD A
No. of poles	3
Degree of protection (EN IEC 60529)	IP67

Side 2

Family construction form	MSUD A
No. of poles	3
Degree of protection (EN IEC 60529)	IP67

Side 3

Family construction form	M12
Coding	A
No. of poles	4
Degree of protection (EN IEC 60529)	IP67

Commercial data

ECLASS-6.0	27143423
ECLASS-6.1	27279218
ECLASS-7.0	27279218
ECLASS-8.0	27279218
ECLASS-9.0	27060312
ECLASS-10.1	27060312
ECLASS-11.1	27060312
ECLASS-12.0	27060312
ETIM-5.0	EC001855
customs tariff number	85444290
GTIN	4048879714655
Packaging unit	1

Electrical data | Supply

Operating voltage AC	24 V
Operating voltage AC min.	19,2 V
Operating voltage AC max.	28,8 V

Operating voltage DC	24 V
Operating voltage DC min.	18 V
Operating voltage DC max.	30 V
Current consumption max.	15 mA

Installation | Connection

Tightening torque	0,6 Nm
Width across flats	SW 13

Device protection | Electrical

Degree of protection (EN IEC 60529)	IP67
Pollution Degree	3
Rated surge voltage	0,8 kV
Material group (IEC 60664-1)	I
Additional suppressor	Z-Diode

Mechanical data | Material data

Locking screw coating	nickel plated
Locking material screw	Zinc die-casting

Mechanical data | Mounting data

Mounting method	inserted, screwed
-----------------	-------------------

Important installation notes

Note on strain relief	Protect the connectors by suitable measures from mechanical loads, e.g. by the usage of cable ties.
Note on bending radius	Attention: Observe the permissible bending radii when laying cables, as the IP protection class can be endangered by excessive bending forces.

Installation | Cable

wire arrangement	black 1, black 2, black 3, green-yellow
Cable identification	227
Cable Type	2
Printing color of wire insulation	white (isolation black)
Jacket Color	gray
Type of Certificate	cURus
Amount stranding	1
Stranding	4 wires twisted
wire arrangement	black 1, black 2, black 3, green-yellow
Cable weight	74,8 g/m
Material jacket	PUR
Shore hardness jacket	85 ± 5 Shore A
Freedom from ingredients (jacket)	lead-free, cadmium-free, CFC-free, silicone-free
Outer-diameter (jacket)	7 mm
Tolerance outer diameter (sheath)	± 5 %
Material inner jacket	PVC
Color (inner jacket)	yellow
Material wire insulation	PVC
Amount wires	4
Outer diameter insulation	1,8 mm
Outer diameter tolerance core insulation	± 5 %
Shore hardness wire insulation	43 ± 5 Shore D
Ingredient freeness wire insulation	lead-free, cadmium-free, CFC-free, silicone-free
Printing color of wire insulation	white (isolation black)
Amount strands (wire)	42
Diameter of single wires	0,15 mm
Conductor crosssection (wire)	0,75 mm ²
Material conductor wire	Stranded copper wire, bare
Conductor type (wire)	strand class 6

Electrical function wire	Signal
Nominal voltage AC max.	300 V
Current load capacity (standard)	to DIN VDE 0298-4
Current load capacity min. wire	9,6 A
Electrical function wire	Signal
Electrical resistance line constant wire	26 Ω /km @ 20 °C
Min. operating temperature (static)	-30 °C
Max. operating temperature (fixed)	80 °C
Operating temperature min. (dynamic)	-5 °C
Operating temperature max. (dynamic)	80 °C
chemical resistance	Good, application-related testing
Gasoline resistance	Good, application-related testing
Oil resistance	DIN EN 60811-404
Bending radius (fixed)	10 x Outer diameter
Bending radius (dynamic)	15 x Outer diameter
No. of bending cycles (C-track)	2 Mio. @ 25 °C
Traversing distance (C-track)	5 m @ 25 °C horizontal
Travel speed (C-track)	3,3 m/s @ 25 °C